

HPX-NT Series

High Function and High Performance Fiber Optic Photoelectric Sensors



FEATURES

High Response 120μ sec, Long Distance Scanning 1,400mm with Standard Fiber and High Resolution. (max. 1/80 millions)

Realization of Mode Switchover with One Amplifier for These Specifications.

- Selection possible for standard, high speed and long distance/high resolution with the mode switchover.
 - Standard mode. (response speed 1msec)
 - High speed mode. (response speed 120μ sec)
 - Long distance/high resolution mode. (Scanning distance 1,400mm for use of a standard fiber.)
- Stabilization degree (margin) of light receiving by 3-digit digital display: Incoming light level and detecting margin display.
- Easy setting by a dial switch.
- 4-kind sensitivity and 3-kind workless tuning: 2-step sensitivity, positioning, maximum sensitivity, full-auto tuning, workless tuning. (BGS and reference sensitivity and percent tuning.)
- Optical axis adjustment mode indicating light quantity at adjustment in 0 to 100 digits.
- One-shot output. (The same output timing can be set despite of different target sizes.)
- Prevention of sensor damage for all miswirings.
- Remote tuning function enables easy designing and correction of light quantity decrement. (Function for **HPX-NT3** and **HPX-NT4** only.)



MAJOR FUNCTIONS

• Percent tuning

This percent tuning allows designating the threshold value (sensor operating point) in 50% to 150% range when the quantity of an incoming light (ex. thru scan type without target, etc.) scanned as reference at sensitivity setting by targetless tuning is determined as 100%. This percent designation can be made at every 1%. This tuning method enables free threshold value setting considering light quantity according to applications.

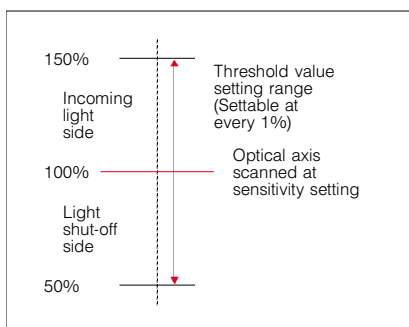

• One-shot output function

Delay function (ON or OFF delay) or one-shot pulse (one-shot ON or OFF) is output programming option that can be used as needed to properly configure the output signal.

Timing can be adjusted in 1ms steps in a range from 1 to 200ms and in 100ms steps in a range from 200ms to 1 second.

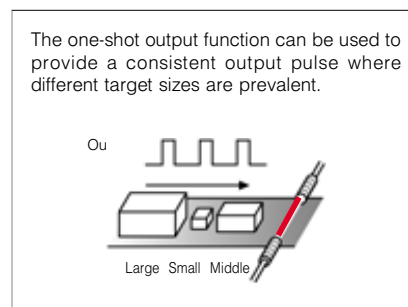

The one-shot output function can be used to provide a consistent output pulse where different target sizes are prevalent.

• Remote tuning function

Re-tuning can be automatically made by pushing a setting push button switch or by a signal from controller.

The tuning contents initially set by manual is executed at receiving of a remote autotuning signal (pink wire).

- Can largely simplify adjustment work in the field.

As amplifier operation is not required for re-tuning at the change of operation process, an operator can save a trouble to directly operate the amplifier.

- Correction of light quantity decrement (LED aging)

Frequent tuning is required for the detection of very narrow difference like a detection of a protruded LCD principle glass or quartz wafer due to the influence of aged LED emitting light quantity. Therefore, remote tuning is executed at each time before detection in connection with machine operation to shift the operating point to correct the influence of light quantity decrement. By this tuning, long time stable detection is enabled. (Targetless tuning [LH] or [PH] is executed at every time by remote tuning.)

AMPLIFIER UNIT ORDER GUIDE

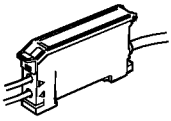
Appearance	Light emitter	Output mode	Remote tuning function	Catalog listing
	Red LED	N-MOS FET Open drain output	None	HPX-NT1
			Available	HPX-NT3
		P-MOS FET Open drain output	None	HPX-NT2
			Available	HPX-NT4
	Blue LED	N-MOS FET Open drain output	None	HPX-NTB1
			Available	HPX-NTB3
P-MOS FET Open drain output	None	HPX-NTB2		
	Available	HPX-NTB4		

AMPLIFIER UNIT SPECIFICATIONS

Catalog listing	HPX-NT1, HPX-NT3	HPX-NTB1, HPX-NTB3	HPX-NT2, HPX-NT4	HPX-NTB2, HPX-NTB4
Power supply	12 to 24Vdc ±10% (ripple 10% P-P max.)			
Power consumption	750mW max. (current consumption 30mA at power supply voltage 24Vdc)			
Detection target	Non-transparent object of more than 1mm dia. (at use with HPF-T003)			
Standard detection target	White paper (at use of HPF-D002)			
Hysteresis	20% max. (at rated scanning distance)			
Operation mode	Light ON/dark ON changeover (Setting by L-ON/D-ON changeover switch)			
Output mode	N-MOS FET open drain output		P-MOS FET open drain output	
Control output	Switching current: 100mA max. (resistive load), Output dielectric strength: 26.4V, Voltage drop: 2V max. (at switching current 100mA), With power short-circuit protection circuit			
Response time	Standard	1ms max. for both operation and recovery		
	Ultra long distance	5ms max. for both operation and recovery		
	High speed response	120µs max. for both operation and recovery		
Remote tuning	Available for HPX-NT3		Available for HPX-NT4	
Timer	Delay	Adjustable ON/OFF delay (1ms to 1s: 1ms to 200ms by 1ms step, 200ms to 1s by 100ms step)		
	One-shot	Adjustable one-shot/OFF timer (1ms to 1s: 1ms to 200ms by 1ms step, 200ms to 1s by 100ms step)		
Light emitter	Red LED	Blue LED	Red LED	Blue LED
Indicating function	Incoming light level, setting status, operation indicator, mode indication (RUN, SET, TMR and ADJ)			
Ambient light immunity	Incandescent lamp: 3,000lx max., Sunlight: 10,000lx max.			
Operating temperature	-20 to +55°C (Note)			
Storage temperature	-40 to +70°C			
Ambient humidity	35 to 85%RH (no condensation allowed)			
Insulation resistance	20MΩ min. (at 500Vdc)			
Dielectric strength	1,000Vac 50/60Hz for one minute between electrically live metals and case			
Vibration resistance	10 to 55Hz, 1.5mm peak-to-peak amplitude, for 2 hours in each of X, Y and Z directions			
Shock resistance	500ms ² , 3 times in each of X, Y and Z directions			
Weight	Approx. 65g (body only with 2m cable)			
Circuit protection	Output is disabled during Power On (approx. 200msec), Output reverse connection protection circuit			

- Installation Instructions No.: **CP-UM-5210E**

Note. Operating temperature range depends on the number of gang-mounted units.

[1 to 2 units: -20 to +55°C, 3 units: -20 to +50°C, 4 to 5 units: -20 to +45°C, 6 units: -20 to +40°C]

Do not apply gang-mounting method if the operating temperature becomes higher than the above-listed temperature.

EXTERNAL DIMENSIONS

● Amplifier unit

(unit: mm)

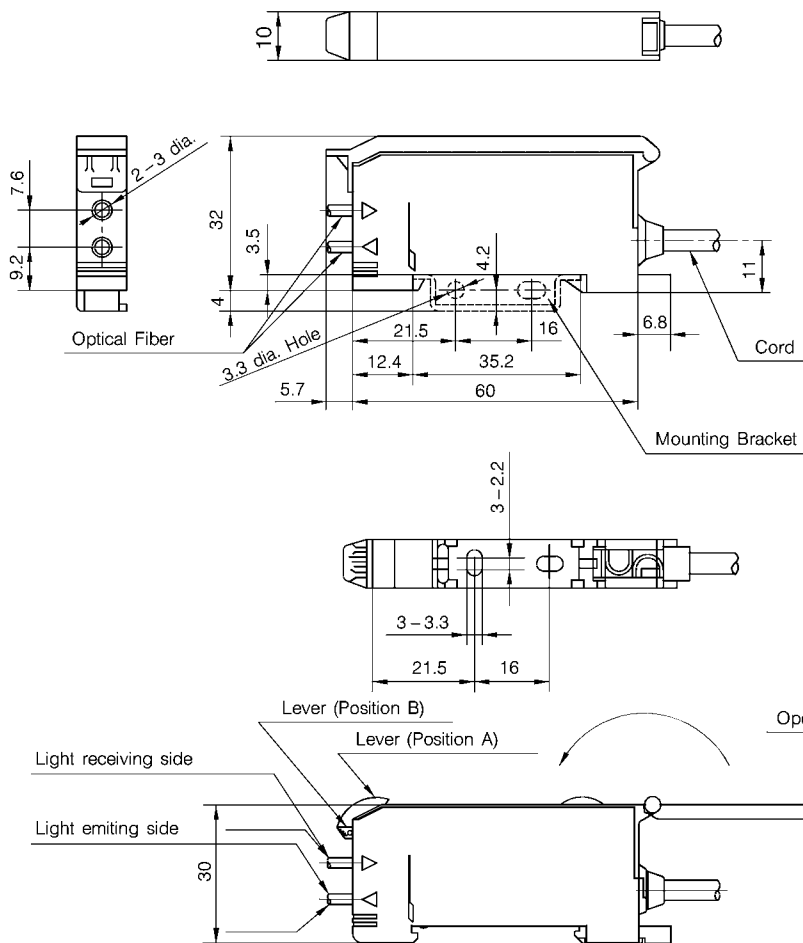

Note 1. Material

Body: PC/ABS alloy resin, gray
Operating cover: PC resin, clear gray

Note 2. Cord:

Oil-proof type
4.2mm outer diameter, 3 cores, 0.2 mm² cross section
Sheath color: Gray

NAMES OF PARTS

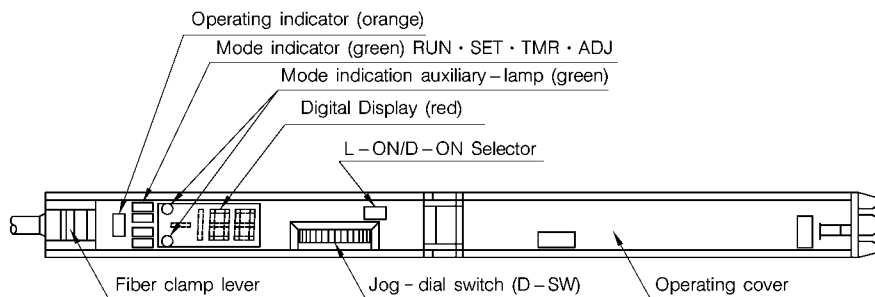

TUNING CHART (Manual operation)

R, P, and P3 in the chart shows the following actions:



R: Rotate SW (dial-switch).



P: Press SW (dial-switch).

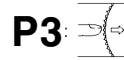

P3: Press SW (dial-switch) for more than 3 sec.

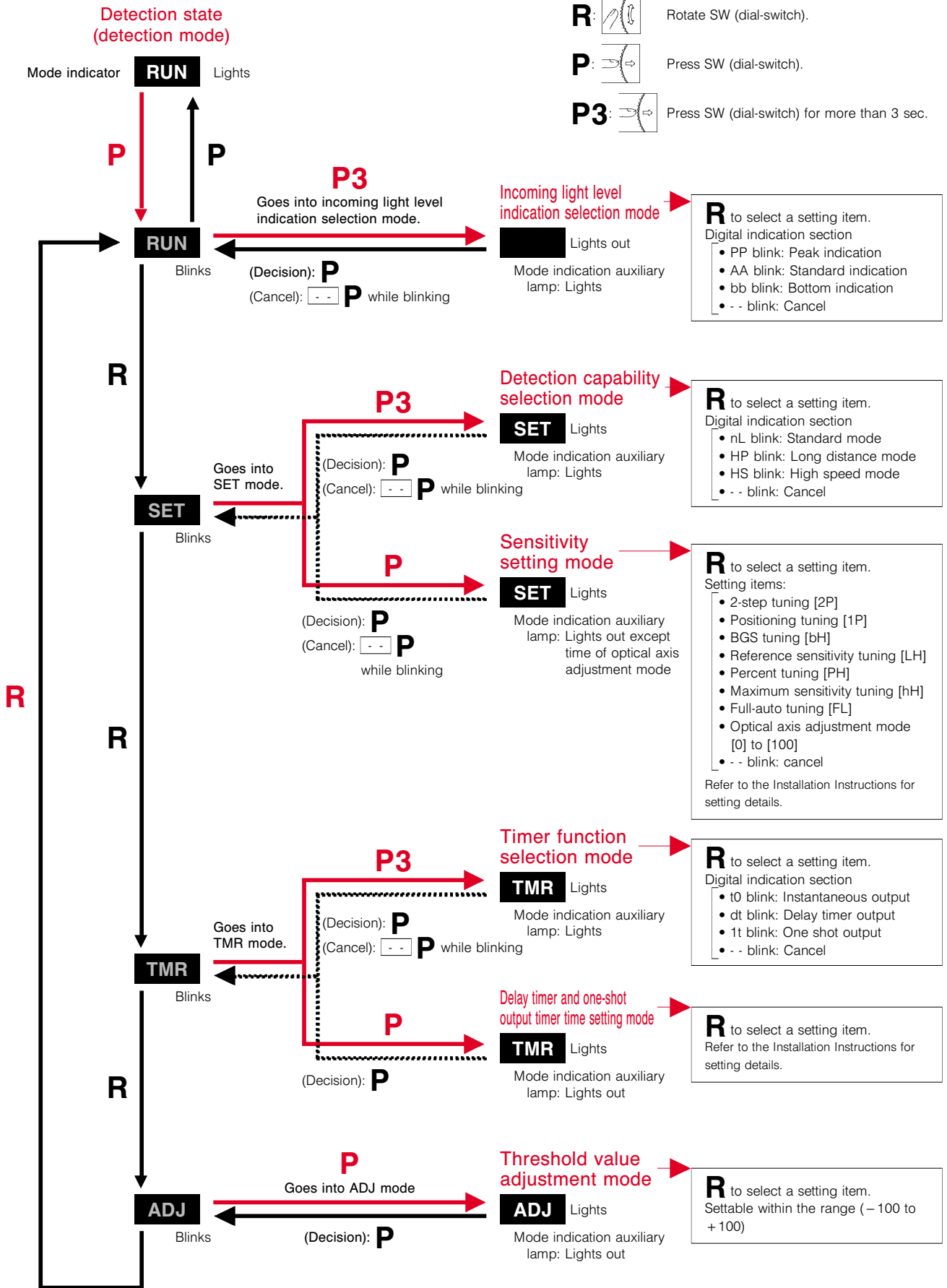

REMOTE TUNING

The **HPX-NT3** and **HPX-NT4** models have the capability to make auto-tuning again by a remote input from a remote location. (Firstly, the tuning decided by manual tuning is executed by remote tuning signal input.) By short-circuiting the pink wires, the remote tuning is executed. (Refer to the circuit diagram.)

The remote tuning of the following items can be executed:

- 2-step sensitivity tuning [2P]
- positioning sensitivity tuning [1P]
- BGS [bH]
- Reference sensitivity tuning [LH]
- Percent tuning

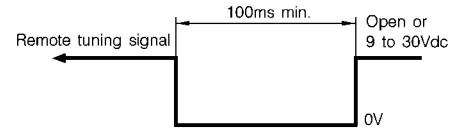

Note: In case of 2-step sensitivity tuning, enter the remote signal for each of the presence and absence of target. Shift the time for more than 1 second between the first and the second signals.

OUTPUT CIRCUIT DIAGRAM

• N-MOS type (HPX-NT1, HPX-NT3)

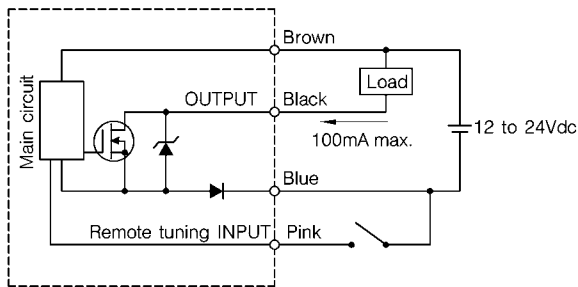

• P-MOS type (HPX-NT2, HPX-NT4)

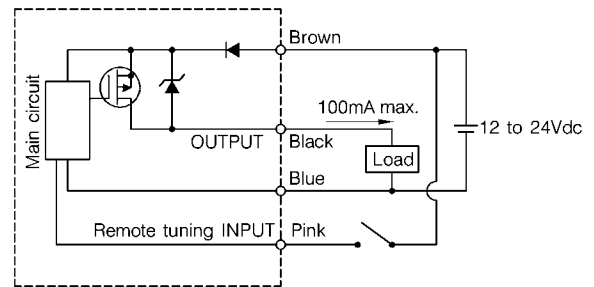

Note: Remote tuning INPUT (Pink) is available for **HPX-NT3** and **HPX-NT4**.

AMPLIFIER MOUNTING METHOD

• Mounting Amplifier

Mount the amplifier on the original bracket (attached to the amplifier) or the DIN rail.

- Engage the (A) part shown below to one rail of the original bracket or the DIN rail.

- Push the (B) part downwards until it clicks.

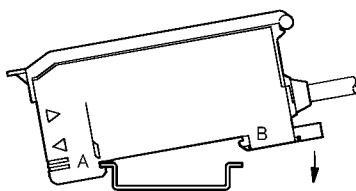

• Dismounting Amplifier

If the amplifier are pushed in the directions of the arrows in the figure, the lock lever can be released.

The amplifier can be picked up as a figure.

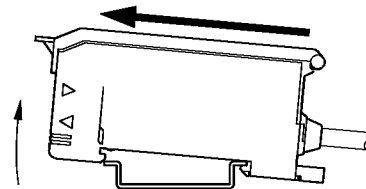

BASIC PRECAUTIONS

• Wiring

- If an extension of cable is necessary, use a 0.3mm² minimum cable of 100m maximum length.
- If the wires of photoelectric sensor are laid in the same conduit together with high-voltage or power lines, incorrect operation or damage may be caused by the inductance.
- When using a commercially available switching regulator, ground the FG (frame ground) and G (ground) terminals, otherwise the switching noise may cause incorrect operation.
- When using a load which generates a inrush current above the switching capacity (e.g. capacitive load, incandescent load), connect a current-limiting resistor between the load and the output terminal, otherwise the output short-circuit protection may function.



• Handling

- Output is disabled upon power-up approx. 200ms so that stabilization occurs.
- Be careful of mutual interference when several sensors applied in close proximity. Make sure to check the individual operation before starting.
- Application with a lot of vibration or shock should be avoided due to potential for misalignment of optical axis.
- Keep dust away from fiber head by using sealed case and air purge.
- Secure the sensor's correct operation by a cover or changing mounting direction if light disturbance is considerable.

- Do not splash water/oil continuously onto the cable and do not dip it into water/oil.
- Fiber head should be protected from oil and water.
- Do not expose **HPX-NT** to ketones, halogenated hydrocarbons, esters, amines, or acids and alkalis.
- Cord cut may occur when cord is pulled with over 50N.
- Install the fiber unit with cord is ties, so that no damage may occur due to excessive force.
- Do not bend the part of the cord nearest to the amplifier with less than a minimum bend radius of 30mm and also avoid continuous bending stress.
- Wipe the surface of the fiber unit's head with soft cloth (dry or with a little water).
- Do not use a product such as benzine, acetone or thinner.
- Do not hit nor rub sensor (especially surface of the fiber unit's head).
- Handle the sensor with care.



TROUBLESHOOTING FOR SHORT-CIRCUIT AND MUTUAL INTERFERENCE

• Short-circuit

When the digital indication section alternatively shows  and , the short-circuit protection function is working. Recheck the wiring.

• Mutual interference

When mutual interference occurs between 2 amplifier units, take the following procedure:

For the first amplifier unit, enter the **SET mode** ⇒ **Detection capability selection mode** and press the dial switch for more than 8 seconds while  is blinking (cancel).  is digitally displayed. ( ⇒ **F1** ⇒ **F2**) is displayed by rotating the dial.)

At this point, make decision on **F1** by pressing the dial switch.

For the second amplifier unit, enter the same setting mode as the first amplifier unit and make decision on **F2**.

The above procedure can prevent the mutual interference between 2 amplifier units.

Note: When F1 is selected for the first amplifier unit, F2 must be selected for another amplifier unit. This setting must be made to the pair for use.



RESTRICIONS ON USE

This product has been designed, developed and manufactured for general-purpose application in machinery and equipment. Accordingly, when used in applications outlined below, special care should be taken to implement a fail-safe and/or redundant design concept as well as a periodic maintenance program.

- Safety devices for plant worker protection
- Start/stop control devices for transportation and material handling machines
- Aeronautical/aerospace machines
- Control devices for nuclear reactors

Never use this product in applications where human safety may be put at risk.

YAMATAKE

Specifications are subject to change without notice.

Yamatake Corporation
Advanced Automation Company

International Business Headquarters

Totate International Building

2-12-19 Shibuya Shibuya-ku

Tokyo 150-8316 Japan

URL:<http://www.yamatake.com>

This has been printed on 100% recycled paper.

(01)

Printed in Japan (SP)

1st Edition: Issued in Apr., 2002

2nd Edition: Issued in Oct., 2003