



Order example

MCHQ – 64 M – OS

MODEL

BODY DIAMETER

64
80
100
125
160

M: Magnet

Mechanical gripping force safety device for O.D. gripping even with a drop pressure

Features

- Compact design enables gripper to be used for a wide range of industrial applications.
- Unit takes high bending moments whilst still giving high gripping force.

Specification

Model	MCHQ				
Acting type	Double acting				
Body diameter(mm)	64	80	100	125	160
Stroke (mm)	12	16	20	26	32
Medium	Air 0.3~0.7 MPa				
Ambient temperature	-5~+60°C (No freezing)				
Lubrication	Not required				
Sensor switch (※)	RH: Reed switch, RHN: NPN, RHP: PNP				
Weight (kg)	0.28	0.45	0.76	1.4	2.5

● Maintenance: Re-Lubrication after appr. 1.5 million cycles recommended.

※ RH specification, please refer to page V-16.

Gripping force in relation to the holding position "L" at 0.6 MPa

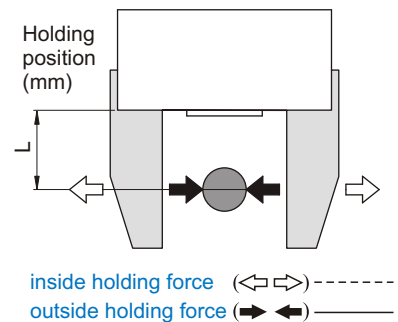
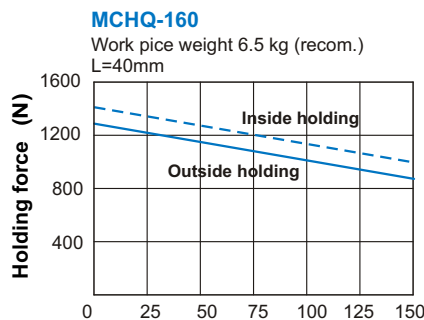
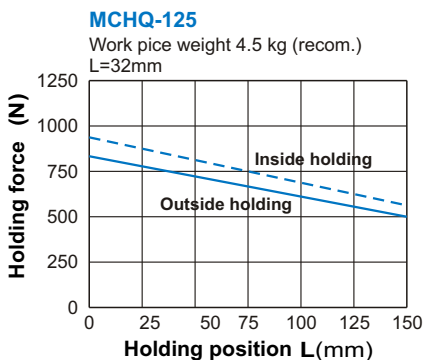
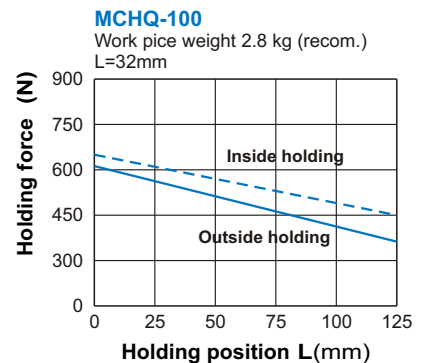
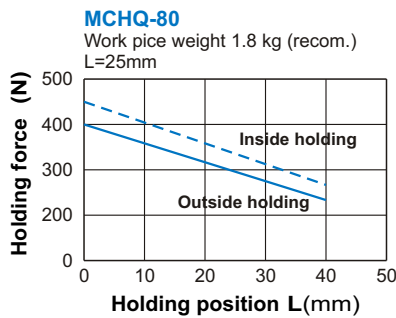
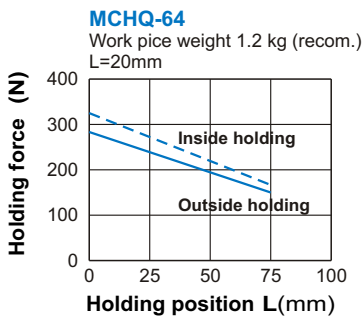

- With reference to the holding force, under the condition must be considered.
- Condition: friction coefficient, great acceleration impact is expected during work piece rotate.
- It recommend: select a type of arithmetic holding force that can produce 10 to 20 times for work piece weight.

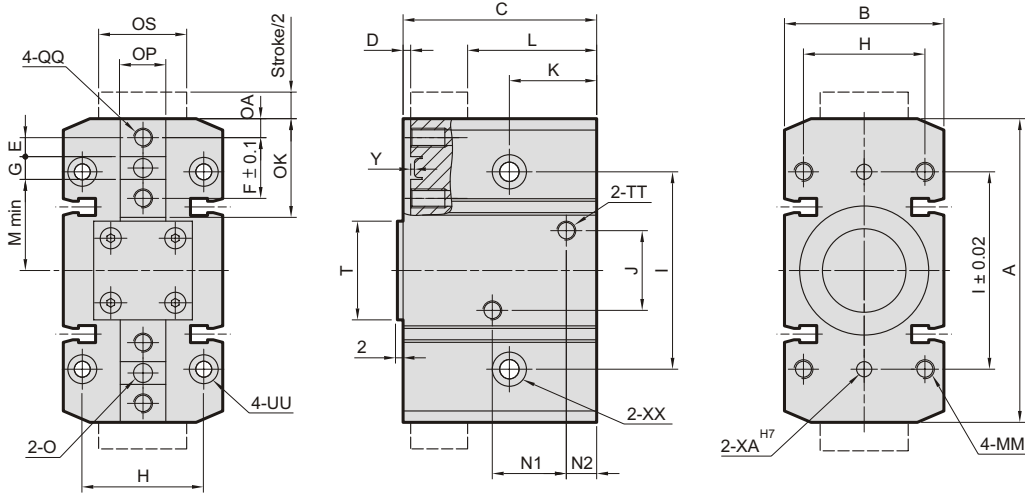

Code Model	A	B	C	D	E	F	G	H	I	J	K	L	M	MM	N1	N2	O	OA	OK	OP	OS	QQ	T	TT
MCHQ-64	64	36	42	2	4	13	5	27	42	16	22	27	19	M5×0.8	7	16.5	φ4	4	20	10	17	M4×0.7×8 dp	20	M5×0.8
MCHQ-80	80	42	51	3	5	16	6	32	52	21	23	34	24	M5×0.8	8	19.5	φ5	5	25	12	23	M5×0.8×10 dp	25	M5×0.8
MCHQ-100	100	50	59	3	6	20	8	38	66	46	20	40	30	M6×1.0	9.5	21.5	φ6	6	32	14	27	M6×1.0×10 dp	28	Rc1/8
MCHQ-125	125	60	68	5	8	24	8	45	82	55	36	44	38	M8×1.25	10.5	22	φ6	8.5	40	16	30	M6×1.0×12 dp	36	Rc1/8
MCHQ-160	160	72	82	3.5	11	32	10	56	100	58	34	55	50	M8×1.25	12	32	φ8	9	50	20	40	M8×1.25×16 dp	46	Rc1/8

Code Model	UU	XA	XX	Y
MCHQ-64	φ 4.2 thru, φ 7.5×26 dp	φ 4	φ 4.5 thru, φ 8×8 dp	2.5
MCHQ-80	φ 4.2 thru, φ 7.5×34 dp	φ 4	φ 5.1 thru, φ 9×24 dp	3
MCHQ-100	φ 5.0 thru, φ 9.1×45 dp	φ 5	φ 8 thru, φ 11×11 dp	3
MCHQ-125	φ 6.8 thru, φ 11×41 dp	φ 6	φ 9 thru, φ 15×14 dp	3.5
MCHQ-160	φ 6.8 thru, φ 11×56 dp	φ 6	φ 9 thru, φ 15×15 dp	4

Finger blanks

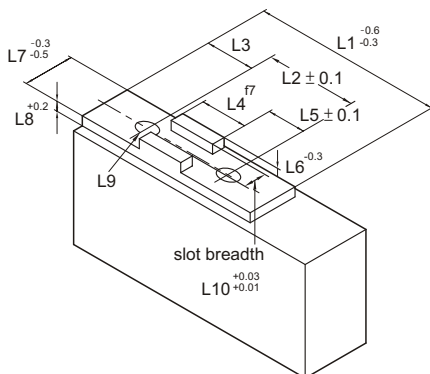

Installation of sensor switch

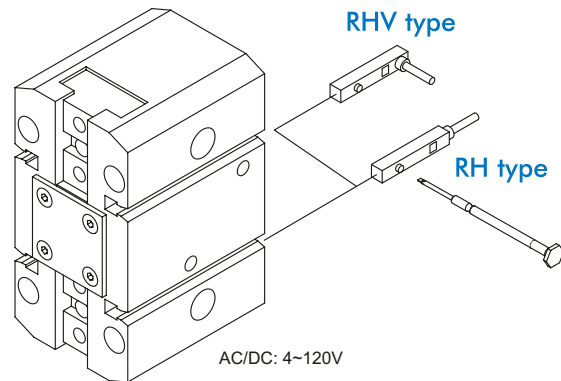

Code Model	L1	L2	L3	L4	L5	L6	L7	L8	L9	L10
MCHQ-64	20	13	4	5	4	2.5	10.2	4.5	φ 4.5	4
MCHQ-80	25	16	5	6	5	3	12.2	5.5	φ 5.5	5
MCHQ-100	32	20	6	8	6	3	14.2	5.5	φ 6.6	6
MCHQ-125	40	24	8.5	8	8	3.5	16.2	5.5	φ 6.6	6
MCHQ-160	50	32	9	10	11	4	20.2	6.5	φ 9	8

LOWER HEIGHT PARALLEL GRIPPERS

Gripping force safety device

Operating pressure min.5 bars,max.6.5 bars

Gripping force = pneum. gripping force + spring force.

Gripping force in relation to the holding position "L" at 0.6 MPa

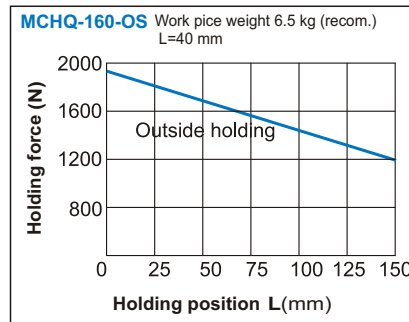
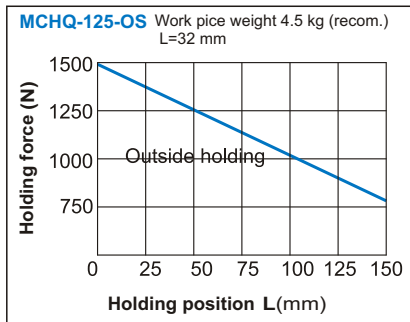
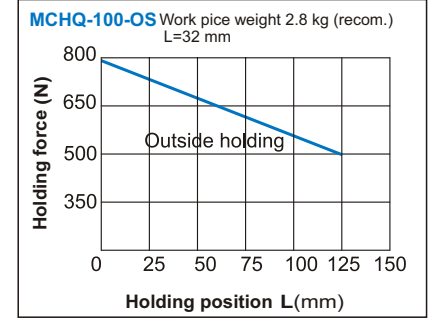
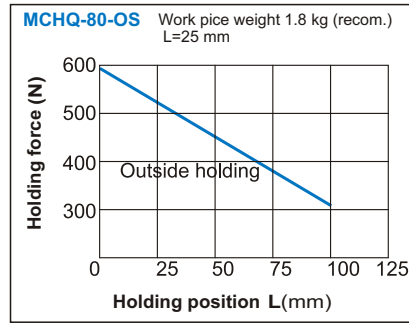
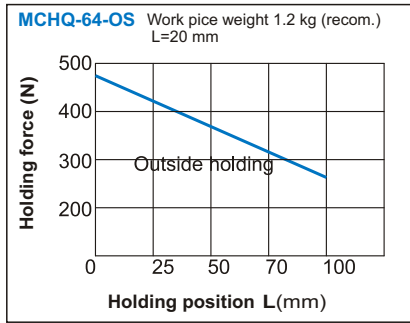

Gripping force safety device for O.D gripping, even with a drop in pressure.

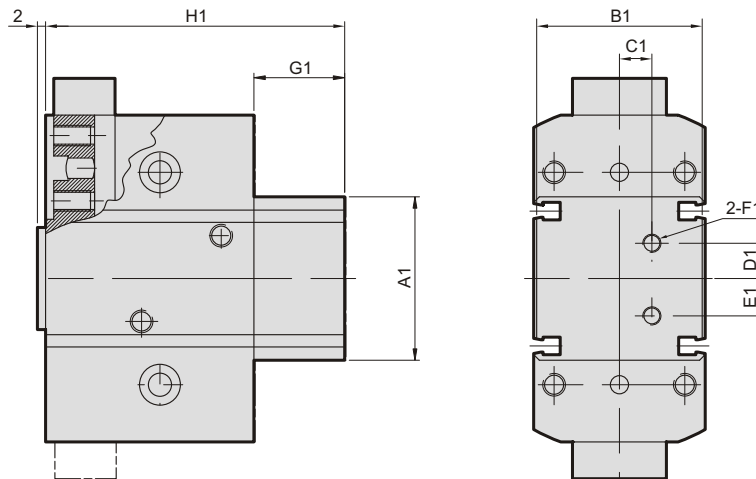

Code Model	A1	B1	C1	D1	E1	F1	G1	H1
MCHQ-64-OS	36	35.5	9	7	7	M5	25	67
MCHQ-80-OS	45	41.5	2	12	14	M5	27	78
MCHQ-100-OS	54	49.5	15.5	17	12	M5	26.5	85.5
MCHQ-125-OS	66	59.5	10	22	22	M5	34.4	102.4
MCHQ-160-OS	80	71.5	12.6	26.5	25	M5	39.2	121.2