

Pressure switch FF 4

0,11 up to 250 bar, ample wiring room, easy to adjust,
high repeatability of set switchpoints, easily read scale



Applications

Air compressors, water pumps, booster pumps, firefighting equipment, or oil supply equipment.

TIVAL pressure switches of the FF 4 series are suitable for a wide range of applications.

For example they can be utilized for:

- Monitoring and controlling the pressure of liquid or gaseous media in pipelines, tanks, vats, pressure vessels and apparatus.
- Applications in process control, cooling, pneumatics and hydraulics.
- Pressure monitoring of cooling circuits and lubrication systems on various types of machinery.
- Automatic switching of pump and compressor motors for supplying water to dwellings, booster pumps, firefighting equipment and on compressed air systems.

Description

The pressure of the monitored medium operates against a flat diaphragm, bellows or plunger (depending on pressure range). A system of levers and springs work on a snapaction cascade switch of high vibration resistance, ensuring flutterfree switching. With no pressure on the diaphragm contact 1-2 is closed. This can be used as an „ON“ signal for a pump or compressor motor. If pressure exceeds the upper switchingpoint, contact 1-2 opens and contact 1-4 closes. The connected motor will be switched off. Contact 1-4 is often used to indicate the „off“ condition.

Contact 1-2 will close again, when the pressure on the diaphragm has dropped below the set lower switchpoint. Upper and lower switch points can be adjusted independently of each other using a screwdriver. The two switch points are indicated on the scale inside the unit.

Change-over contact with manual reset min.:

If the pressure drops below the set value, contact 1-4 opens and contact 1-2 closes and locks. When the pressure has risen above the set value, the contact can be unlocked with the manual reset button.

Change-over contact with manual reset max.:

If the pressure rises above the set value, contact 1-2 opens and contact 1-4 closes and locks. When the pressure has dropped below the set value, the contact can be unlocked with the manual reset button.

Pressure connection, pressure sensing element, switch mechanism and electrical terminals are fitted on a die-cast aluminum-alloy base. The scale and switch are protected against environmental effects by an impact-resistant, transparent polycarbonate cover, (CTI 200-225) and can be lead-sealed.

Included in standard units: Rubber grommet with orifice for cable entry, pressure connector „Y“, made out of plastic for demineralised water applications.

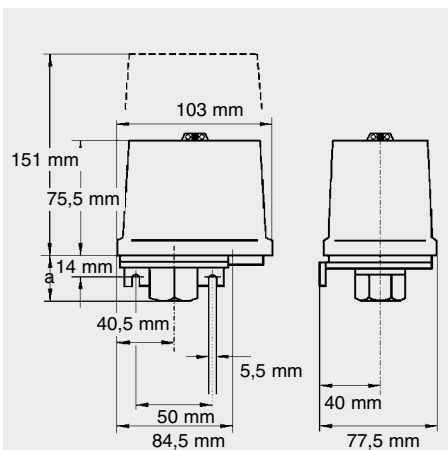

**FF 4-2, FF 4-4, FF 4-8,
FF 4-16, FF 4-32**

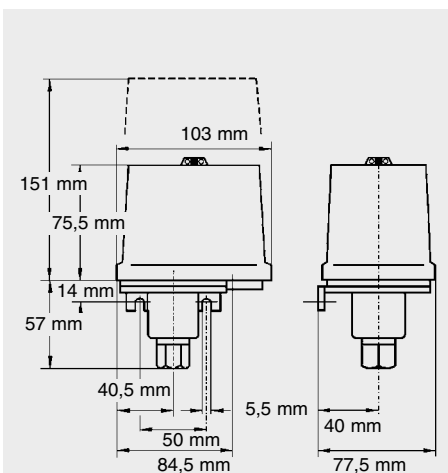

**FF 4-12, FF 4-30, FF 4-60,
FF 4-120, FF 4-250**

Options upon request:

- Gold flashed contacts
- Cable gland M 20 for protection IP 65
- Viton diaphragm for aggressive media
- Manual reset

- GL - approved version
- UL/CSA - approved version
- ATEX - approved version
- VdS - approved version

Pressure switch FF 4

0,11 up to 250 bar, ample wiring room, easy to adjust,
high repeatability of set switchpoints, easily read scale

Types

Pressure switch with perbunan diaphragm for mineral oils, water and air. Additional type **G = gold flashed contacts**

Pressure connector: H (G 3/8" Female thread, DIN 1725/2), ALSi 12. VDE 0660, IEC 337-1, IEC 553-1

Order reference	Upper switch pt. adjustable (bar)	Lower switch pt. adjustable (bar)	Smallest diff.* (bar)	Max. operating pressure (bar)	Max. test pressure (bar)	Standard setting (bar)	Part No.
FF 4-2 DAH	0,11 ... 2	0,04 ... 1,89	0,07 0,11	20	40	0,5 / 1,5	1010061
FF 4-2 DAH G	0,11 ... 2	0,04 ... 1,89	0,07 0,11	20	40	0,5 / 1,5	1010109
FF 4-4 DAH	0,22 ... 4	0,07 ... 3,75	0,15 0,25	24	40	1 / 3	1010062
FF 4-4 DAH G	0,22 ... 4	0,07 ... 3,75	0,15 0,25	24	40	1 / 3	1010012
FF 4-8 DAH	0,5 ... 8	0,2 ... 7,5	0,3 0,5	30	40	2 / 6	1010078
FF 4-8 DAH G	0,5 ... 8	0,2 ... 7,5	0,3 0,5	30	40	2 / 6	1010096
FF 4-16 DAH	1 ... 16	0,4 ... 15	0,6 1	36	48	4 / 12	1010081
FF 4-16 DAH G	1 ... 16	0,4 ... 15	0,6 1	36	48	4 / 12	1010102
FF 4-32 DAH	2 ... 32	0,8 ... 30	1,2 2	52	64	10 / 20	1010076
FF 4-32 DAH G	2 ... 32	0,8 ... 30	1,2 2	52	64	10 / 20	1010003

* at lower ... higher end of range

Types

Pressure switch with perbunan diaphragm and plastic pressure connector suitable i.e. for demineralised water.

Pressure connector: Y (G 3/8" Female thread, DIN 1725/2), polyamid. VDE 0660, IEC 337-1, IEC 553-1



Control pressure switch FF 4... DAY

Order reference	Upper switch pt. adjustable (bar)	Lower switch pt. adjustable (bar)	Smallest diff.* (bar)	Max. operating pressure (bar)	Max. test pressure (bar)	Standard setting (bar)	Part No.
FF 4-2 DAY	0,11 ... 2	0,04 ... 1,89	0,07 0,11	6	12	0,5 / 1,5	1010077
FF 4-4 DAY	0,22 ... 4	0,07 ... 3,75	0,15 0,25	8	12	1 / 3	1010063
FF 4-8 DAY	0,5 ... 8	0,2 ... 7,5	0,3 0,5	12	16	2 / 6	1010084
FF 4-10 DAY	0,7 ... 10	0,3 ... 9,2	0,4 0,8	12	16	4 / 5	1010073
FF 4-16 DAY	1 ... 16	0,4 ... 15	0,6 1	20	24	4 / 12	1010082

* at lower ... higher end of range

Pressure switch FF 4

0,11 up to 250 bar, ample wiring room, easy to adjust,
high repeatability of set switchpoints, easily read scale

Types

**Pressure switch with stainless steel bellows Declaration of Conformity in acc. with PED,
media temperature up to +200° C, de-ionised water**

Pressure connector: G (G 1/4" Female thread DIN 1725/2), stainless steel. VDE 0660, IEC 337-1, IEC 553-1



Control pressure switch FF 4-... AAG / PAH

Order reference	Upper switch pt. adjustable (bar)	Lower switch pt. adjustable (bar)	Smallest diff.* (bar)	Max. operating pressure (bar)	Max. test pressure (bar)	Standard setting (bar)	Part No.
FF 4-12 AAG	1 ... 12	0,5 ... 11,2	0,5 0,8	12	16	6 / 7	1010074
FF 4-30 AAG	4 ... 30	1 ... 26,4	1,8 3,6	30	42	16 / 20	1010066

* at lower ... higher end of range

Types

High pressure switch with plastic plunger.

Throttle is fitted as standard on these units. This must be removed for use with viscous media.

Pressure connector: H (G 3/8" Female thread, DIN 1725/2), stainless steel. VDE 0660, IEC 337-1, IEC 553-1

Order reference	Upper switch pt. adjustable (bar)	Lower switch pt. adjustable (bar)	Smallest diff.* (bar)	Max. operating pressure (bar)	Max. test pressure (bar)	Standard setting (bar)	Part No.
FF 4-60 PAH	8 ... 60	4 ... 52	4 8	100	120	20 / 40	1010064
FF 4-120 PAH	16 ... 120	8 ... 104	8 16	200	240	20 / 80	1010079
FF 4-250 PAH	30 ... 250	14 ... 226	12 24	400	500	100 / 200	1010072

* at lower ... higher end of range

Pressure switch FF 4

0,11 up to 250 bar, ample wiring room, easy to adjust,
high repeatability of set switchpoints, easily read scale

Types

Pressure switch with manual reset DDH = reset min., DRH = reset max.

Pressure connector: H (G 3/8" Female thread, DIN 1725/2), ALSi 12. VDE 0660, IEC 337-1, IEC 553-1



Control pressure switch FF 4-... with manual reset

Order reference	Upper switch pt. adjustable (bar)	Lower switch pt. adjustable (bar)	Smallest diff. (bar)	Max. operating pressure (bar)	Max. test pressure (bar)	Standard setting (bar)	Part No.
FF 4-2 DRH	0,11 ... 2		0,2	20	40	0,5 / 1,5	1010106
FF 4-2 DDH		0,04 ... 1,89	0,1	20	40	0,5 / 1,5	1010107
FF 4-4 DRH	0,22 ... 4		0,5	24	40	1 / 3	1010016
FF 4-4 DDH		0,07 ... 3,75	0,2	24	40	1 / 3	1010100
FF 4-8 DRH	0,5 ... 8		1,0	30	40	2 / 6	1010069
FF 4-8 DDH		0,2 ... 7,5	0,4	30	40	2 / 6	1010094
FF 4-16 DRH	1 ... 16		2,0	36	48	4 / 12	1010110
FF 4-16 DDH		0,4 ... 15	0,8	36	48	4 / 12	1010101
FF 4-32 DRH	2 ... 32		4,0	52	64	10 / 20	1010057
FF 4-32 DDH		0,8 ... 30	1,6	52	64	10 / 20	1010087

Pressure switch FF 4

0,11 up to 250 bar, ample wiring room, easy to adjust,
high repeatability of set switchpoints, easily read scale

Types

Pressure switch with UL / CSA-approval IP 65 for mineral oils, water and air.

Pressure connector: F (1/4"18 NPTF), silumin. Cable gland 1/2" 14 NPTF is fitted as standard on these units.

VDE 0170/0171/0660, IEC 337-1, IEC 553-1



Control pressure switch FF 444-... with UL / CSA-approval

Order reference	Upper switch pt. adjustable (psi)	Lower switch pt. adjustable (psi)	Smallest diff.* (psi)	Max. operating pressure (psi)	Max. test pressure (psi)	Standard setting (psi)	Part No.
FF444-V2 DAF	3 ... 58	1 ... 54	2 4	348	580	14 / 44	1010309
FF444-V4 DAF	15 ... 232	6 ... 217	9 14	522	696	58 / 174	1010311
FF444-V6 PAF	116 ... 870	58 ... 754	58 116	1450	1740	290 / 580	1010299
FF444-V7 PAF	232 ... 1740	116 ... 1508	116 232	2900	3840	290 / 1160	1010300

* at lower ... higher end of range

Technical data							
Rated operating current at	12 V	24 V	60 V	110 V	230 V	400 V	
AC 1					16 A	10 A	
AC 15					6 A	4 A	
DC 13	6 A	1 A	0,5 A	0,2 A	0,1 A		
Permissible motor power 1 ~ 230 V	0,55 kW						
Rated operating current AC 3	10 A						
Resistance to vibration 10 to 1000 Hz	4 g						
Protection acc. to DIN 40 050 / IEC 529 with rubber grommet	IP54						
Protection acc. to DIN 40 050 / IEC 529 with cable glands PG 13.5 / M20	IP65						
Ambient temperature range	-20 ... +70° C						
Perm. media temperature (... DAH, PAH, DAF)	+70° C						
(...DAY)	+50° C						
(...AAG)	+200° C						
Repeatability	< 2 % FS						
Electrical lifespan	AC 15 – at least 1 * 10 ⁶						
Max. switching frequency	30 * min ⁻¹						

Pressure switch FF 4

0,11 up to 250 bar, ample wiring room, easy to adjust,
high repeatability of set switchpoints, easily read scale

Media compatibility guide

Medium name	Chemical Formula	Stainless steel	Perbunan	Viton	Plastic
Acetone	CH ₃ COCH ₃	X			
Acetylene	HC = CH	X	X	X	X
Air	-	X	X	X	X
Benzene	Sulphur-free	X		X	
Butane	C ₄ H ₁₀	X	X	X	X
Butyl acetate	CH ₃ COOC ₄ H ₉	X			
Butyl alcohol	CH ₃ -CH ₂ -CH ₂ -CH ₂ -OH	X			
Carbon dioxide	CO ₂	X	X	X	X
Carbonic acid	H ₂ CO ₃	X	X	X	X
Chlorine	Cl ₂			X	
Crude oil	-	X	X	X	X
Diesel oil	See fuels	X	X	X	X
Ethyl acetate	CH ₃ OOOC ₂ H ₅	X			
Fuels	Diesel oil,	X	X	X	X
	Leaded petrol	X	X	X	X
	Benzene	X		X	
Glycerine	CH ₂ OH-CHOH-CH ₂ OH	X	X	X	X
Glycol	CH ₂ OH-CH ₂ OH	X	X	X	X
Heating fuel oil	See also oils	X	X	X	X
Hydrogen	H ₂	X	X		X
Inert gases	-	X			
Methanol	CH ₃ OH	X			
Methyl chloride	CH ₃ Cl	X			
Natural gas	-	X	X	X	X
Nitrogen	N ₂	X	X	X	X
Oils	Mineral	X	X	X	X
Oils	Vegetable	X	X	X	
Oxygen	O ₂	X		X	
Ozone	-	X		X	
Perchlorethylene	CCl ₂ =CCL ₂	X		X	
Petrol	All types	X		X	
Phenolic acid	C ₆ H ₅ (OH)	X			
Sulphar dioxide	SO ₂	X		d	
Toluene (Metyl benzene)	C ₆ H ₅ CH ₃	X		X	
Trichlorethene	CHCl=CCL ₂	X		X	
Water	Steam / vapor	X	X	X	
Water	Distilled, de-aerated	X	X	X	X
Water	Sea water	X	X		
Xylene	C ₆ H ₄ (CH ₃) ₂	X		X	

X = recommended, d = dry

Accessories

Order reference	Description	Weight (g)	Part No.
	Throttles		
Throttle FF4-2 ... 32	Throttle for series FF4-2 up to 32	3	1011002
Throttle FF4-60 ... 250	Throttle for series FF4-12/30/60/120/250 (stainless steel)	3	1011003
	Glands		
H 124-114	Steel gauge fitting, G 3/8" - G 1/2"	180	1071004
Gland M 20	Glands FF4	-	1011004
Nut M 20	Nut FF4	-	1011007
	Cover		
Cover FF4	Cover FF4	-	1011001

Pressure switch FF 4

0,11 up to 250 bar, ample wiring room, easy to adjust,
high repeatability of set switchpoints, easily read scale

Dimensions

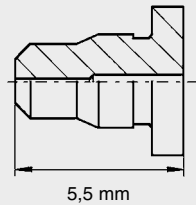

Throttle for FF 4-2 up to 32

weight: ~ 3 g
Order No.: 1011002

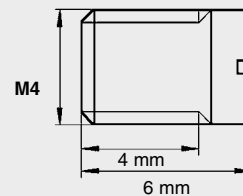

Throttle screw for FF 4-12/30/60/120/250

weight: ~ 3 g (stainless steel)
Order No.: 1011003

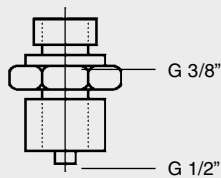

Gauge fitting

Steel, G 3/8" - G 1/2", Type: H 124-114
weight: ~ 18 g
Order No.: 1071004

Circuit diagrams

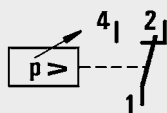

Change-over contact

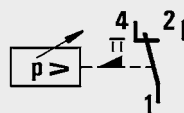

**Change-over contact
with manual reset min.**

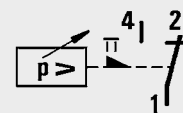

**Change-over contact
with manual reset max.**

Pressure switch FF 4

0,11 up to 250 bar, ample wiring room, easy to adjust, high repeatability of set switchpoints, easily read scale

Pressure diagrams

Charts show the smallest adjustable differential.

Example per figure FF 4-4: If upper setting is at 3.25 bar, lower setting can be adjusted between 0.07 and 3.0 bar (see arrows in the drawing).

FF 4-2

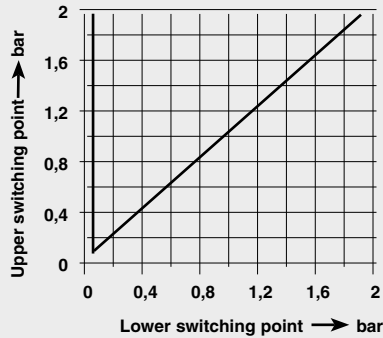

FF 4-4

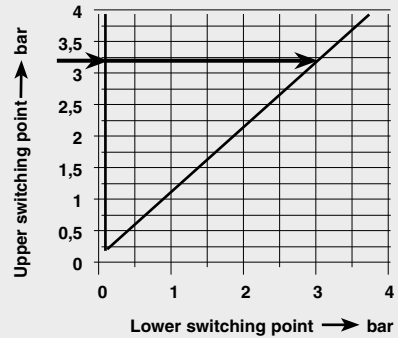

FF 4-8

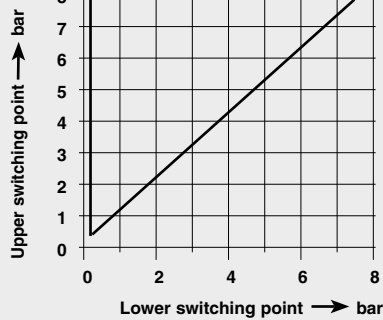

FF 4-12

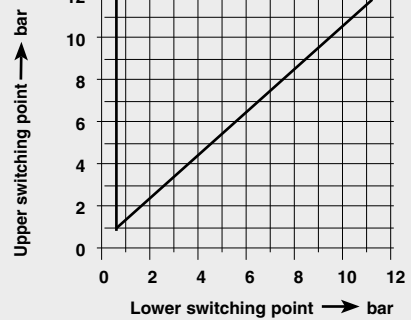

FF 4-16

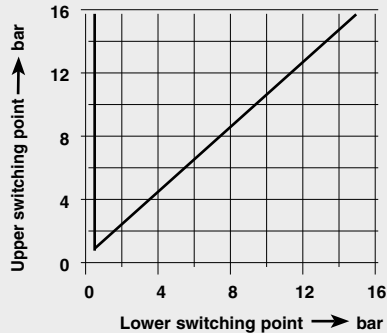

FF 4-30

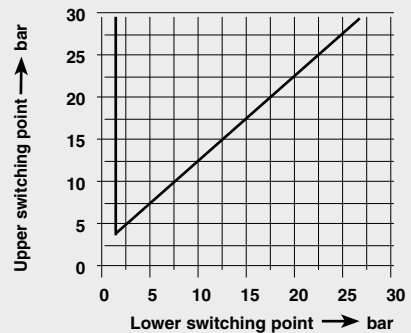

FF 4-32

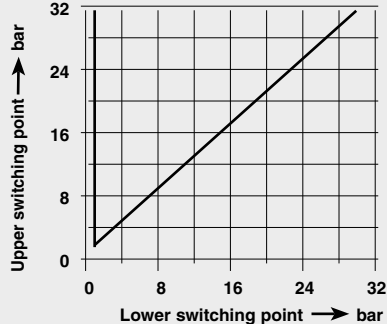

FF 4-60

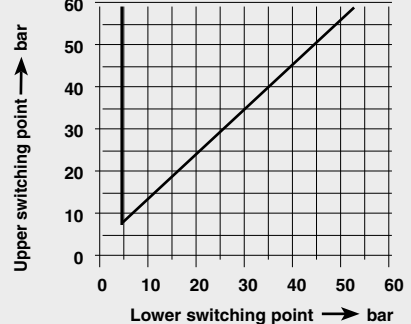

Pressure switch FF 4

0,11 up to 250 bar, ample wiring room, easy to adjust,
 high repeatability of set switchpoints, easily read scale

Pressure diagrams

