

LI100P3-Q25LM2-LIU5X3-H1151

Inductive Linear Position Sensor

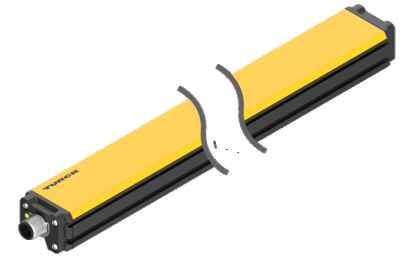
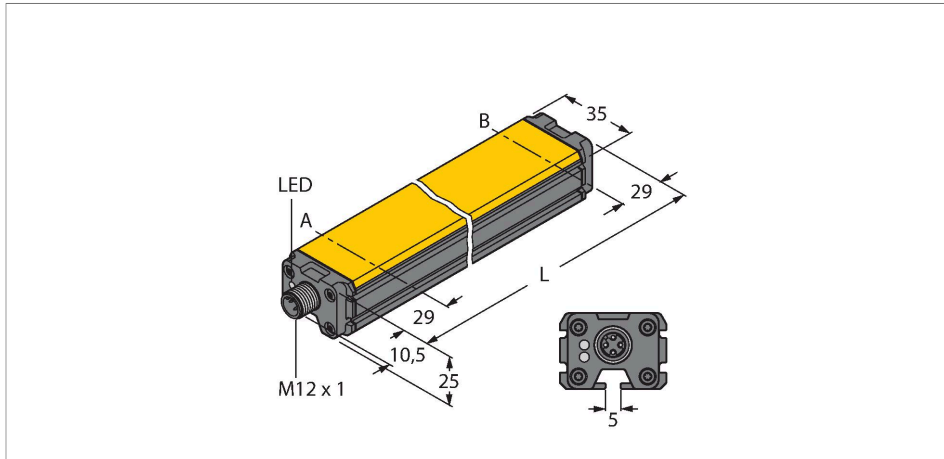

Technical data

Type	LI100P3-Q25LM2-LIU5X3-H1151
ID no.	1590150
Measuring principle	Inductive
Measuring range	100 mm
Resolution	12 bit
Nominal distance	1.5 mm
Blind zone a	29 mm
Blind zone b	29 mm
Repeat accuracy	$\leq 0.026\%$ of full scale
Linearity deviation	$\leq 0.12\%$ f.s.
Temperature drift	$\leq \pm 0.003\%$ / K
Hysteresis	not applied
Ambient temperature	-25...+70 °C
Operating voltage	15...30 VDC
Residual ripple	$\leq 10\%$ U_{ss}
Isolation test voltage	≤ 0.5 kV
Short-circuit protection	yes
Wire breakage/Reverse polarity protection	yes / yes (voltage supply)
Output function	5-pin, Analog output
Voltage output	0...10 V
Current output	4...20 mA
Load resistance voltage output	≥ 4.7 k Ω
Load resistance, current output	≤ 0.4 k Ω
Sample rate	500 Hz

Features

- Rectangular, aluminium / plastic
- Versatile mounting possibilities
- Positioning element P3-Li-Q25L, mounting aid M2-Q25L included in delivery
- LED indicates measuring range
- Immune to electromagnetic interference
- Extremely short blind zones
- Resolution, 12-bit
- 4-wire, 15...30 VDC
- Analog output
- Programmable measuring range
- 0...10 V and 4...20 mA
- M12 × 1 male, 5-pin

Wiring diagram

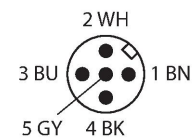
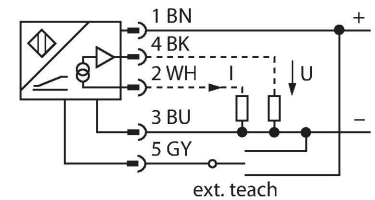

Functional principle

The measuring principle of linear position sensors is based on RLC coupling between the positioning element and the sensor, whereby

Technical data

Current consumption	< 50 mA
Design	Profile, Q25L
Dimensions	158 x 35 x 25 mm
Housing material	Aluminum/plastic, PA6-GF30, Anodized
Active area material	Plastic, PA6-GF30
Electrical connection	Connector, M12 × 1
Vibration resistance	55 Hz (1 mm)
Shock resistance	30 g (11 ms)
Protection class	IP67
MTTF	138 years acc. to SN 29500 (Ed. 99) 40 °C
Power-on indication	LED, Green
Measuring range display	multifunction LED, green, yellow, yellow flashing
Included in delivery	P3-Li-Q25L, M2-Q25L

an output signal is provided proportional to the position of the positioning element. The rugged sensors are wear and tear-free, thanks to the contactless operating principle. They convince through their excellent repeatability, resolution and linearity within a broad temperature range. The innovative technology ensures a high immunity to electromagnetic DC and AC fields.

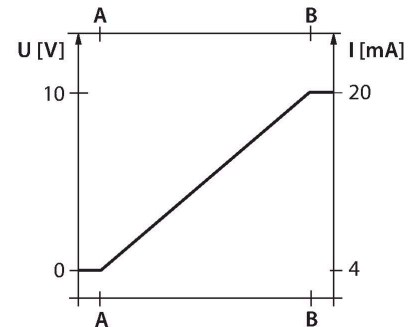

Mounting instructions

Mounting instructions/Description

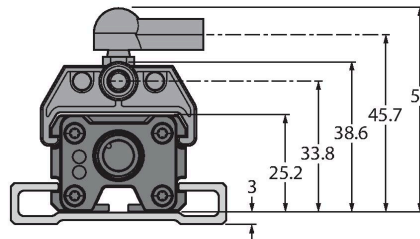
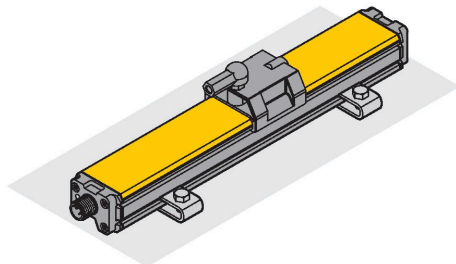

Extensive mounting accessories provide various options for installation. Due to the measuring principle, which is based on the functional principle of an RLC coupling, the linear position sensor is immune to magnetized metal splinters and other interferences.

Status display via LED

Green:
Sensor is supplied properly

LED indicates measuring range

Green:
Positioning element is within the measuring range

Yellow:
Positioning element is within the measuring range, low signal intensity (e.g. distance too large)

Yellow flashing:
Positioning element is outside the detection range

Off:
Positioning element is outside the programmed range (only with teachable versions)

Teaching

The start and end point of the measuring range are set by pressing the button on the teach adapter. Moreover there is the possibility of inverting the course of the output curve.

Bridge pin 5 and pin 1 for 10 s = factory setting
Bridge pin 5 and pin 3 for 10 s = factory setting inverted

Bridge pin 5 and pin 3 for 2 s = sets start value of measuring range

Bridge pin 5 and pin 1 for 2 s = sets end value of measuring range

Accessories

P1-LI-Q25L

6901041

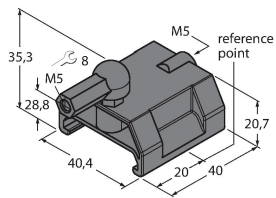

Guided positioning element for linear position sensors LI-Q25L, inserted in the groove of the sensor

P2-LI-Q25L

6901042

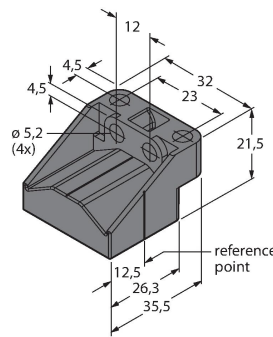

Floating positioning element for linear position sensors LI-Q25L; the nominal distance to the sensor is 1.5 mm; pairing with the linear position sensor at a distance of up to 5 mm or misalignment tolerance of up to 4 mm.

P3-LI-Q25L

6901044

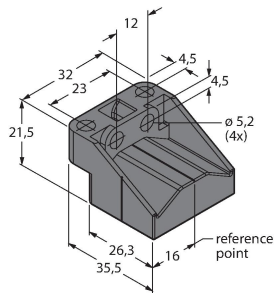

Floating positioning element for Li-Q25L linear position sensors; operational at an offset of 90 degrees; nominal distance to sensor 1.5 mm; pairing with linear position sensor at a distance of up to 5 mm; misalignment tolerance of up to 4 mm

P6-LI-Q25L

6901069

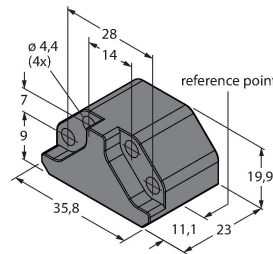

Floating positioning element for linear position sensors LI-Q25L; the nominal distance to the sensor is 1.5 mm; pairing with the linear position sensor at a distance of up to 5 mm or misalignment tolerance of up to 4 mm.

P7-LI-Q25L

6901087

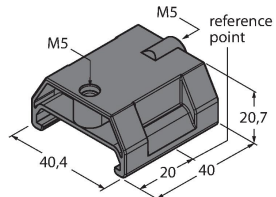

Guided positioning element for linear position sensors LI-Q25L, without ball joint

M1-Q25L

6901045

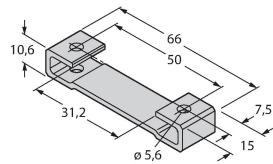

Mounting foot for linear position sensors LI-Q25L; material: aluminum; 2 pcs. per bag

M2-Q25L

6901046

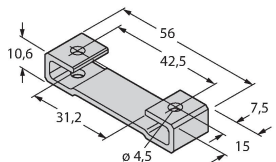

Mounting foot for linear position sensors LI-Q25L; material: aluminum; 2 pcs. per bag

M4-Q25L

6901048

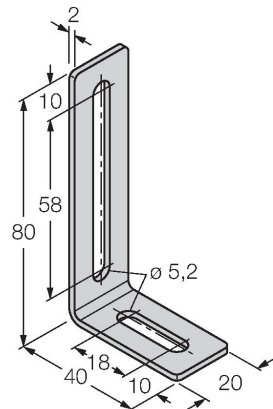

Mounting bracket and sliding block for linear position sensors LI-Q25L; material: Stainless steel; 2 pcs. per bag

MN-M4-Q25

6901025

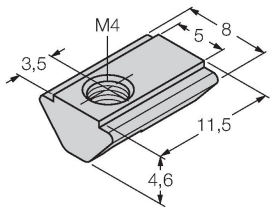

Sliding block with M4 thread for the backside profile of the LI-Q25L; material: galvanized steel; 10 pcs. per bag

AB-M5

6901057

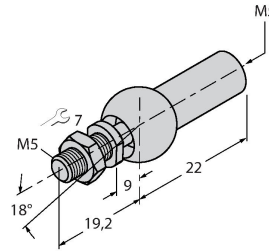

Axial Joint for Guided Positioning Elements

ABVA-M5

6901058

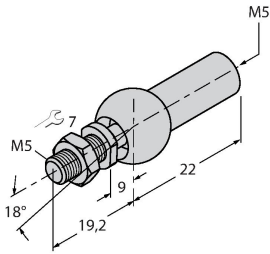

Axial joint for guided positioning element, stainless steel

RBVA-M5

6901059

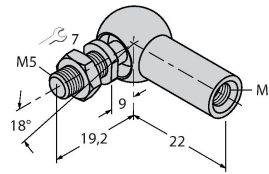

Angle joint for guided positioning element, stainless steel