

Flat Gain Wideband Amplifier

ZVA-403GX+

50Ω 0.050 to 40000 MHz

The Big Deal

- Excellent gain flatness, ± 1.5 dB
- Single +5V supply with 100mA typ. current
- Small package



Case Style: AV2578

Product Overview

Mini-Circuits' ZVA-403GX+ is a coaxial, ultra-wideband amplifier offering flat gain across an extremely wide frequency range from 50 kHz to 40 GHz. This model operates on a single +5V supply with just 100mA typical current consumption, and is capable of delivering up to 20mW output power at 1 dB compression. The amplifier comes in a rugged, compact case (0.84 x 0.96 x 0.36") with 2.92mm RF connectors.

Key Features

Feature	Advantages
Ultra-wideband, 50 kHz to 40 GHz	Enables a single amplifier to be used in a wide range of applications from 5G to satellite, military systems, fiber-optic equipment, test and measurement, and more.
Excellent gain flatness, ± 1.5 dB across full frequency range	Provides consistent performance across its operating frequency, minimizing the need for external equalizing networks in wideband applications.
Single +5V supply	Avoids the requirement for dual supply voltage common among other amplifiers of similar bandwidth, simplifying system design, saving cost and space.
Small package, 0.84 x 0.96 x 0.36"	Saves space in tight system layouts.



Flat Gain Wideband Amplifier

ZVA-403GX+

50Ω 0.050 to 40000 MHz

Features

- Excellent gain flatness, ±1.5 dB typ.
- Uses a single +5V power supply

Applications

- fiber optics
- very wideband test instrumentation
- lab use
- 5G systems



Case Style: AV2578

Connectors	Model No.
2.92mm	ZVA-403GX+

+RoHS Compliant

The +Suffix identifies RoHS Compliance. See our web site for RoHS Compliance methodologies and qualifications

Electrical Specifications at 25°C, V_{dd}=+5.0V, unless noted

Parameter	Condition (MHz)	Min.	Typ.	Max.	Units
Frequency Range		0.050		40000	MHz
Gain	50 - 7500	10.7	12.0	—	dB
	7500 - 15000	10.0	11.5	—	
	15000 - 30000	8.2	11.0	—	
	30000 - 40000	8.0	10.5	—	
Noise Figure	250 - 2000	—	6	—	dB
	2000 - 7500	—	4.5	—	
	7500 - 26500	—	4.0	—	
Input Return Loss	50 - 5000	12.0	14.0	—	dB
	5000 - 15000	8.0	14.0	—	
	15000 - 20000	8.5	16.0	—	
	20000 - 27500	8.0	17.0	—	
	27500 - 40000	8.0	12.5	—	
Output Return Loss	50 - 10000	7.0	10.0	—	dB
	10000 - 20000	8.5	16.0	—	
	20000 - 30000	7.5	15.0	—	
	30000 - 40000	7.0	12.0	—	
Output Power at 1dB Compression	50 - 15000	—	13.0	—	dBm
	15000 - 30000	—	11.0	—	
	30000 - 40000	—	10.0	—	
Output IP3	50 - 30000	—	22.0	—	dBm
	30000 - 40000	—	21.0	—	
Device Operating Current		50.0	100.0	150.0	mA

Absolute Maximum Ratings¹

Parameter	Ratings
Operating Temperature (baseplate)	-10°C to 85°C
Storage Temperature	-55°C to 100°C
Total Power Dissipation	0.75W
Input Power (CW), V _{dd} =5V	+4 dBm
DC Voltage	6V



Outline Drawing

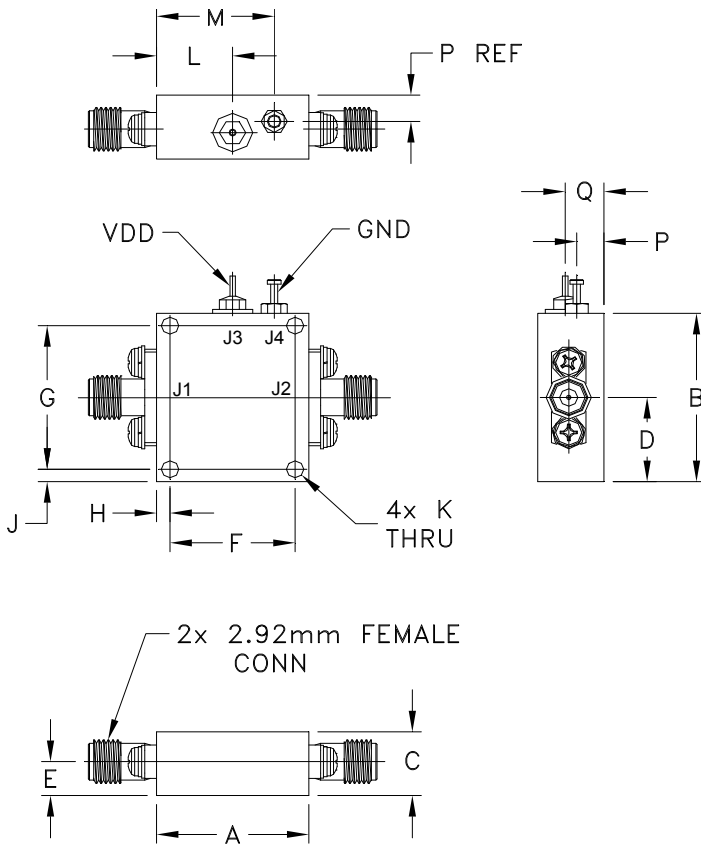

Coaxial Connections

J1	RF IN (DC BLOCKED)
J2	RF OUT (DC BLOCKED)
J3	VDD
J4	GROUND

Outline Dimensions (inch/mm)

A	B	C	D	E	F	G	H	J	K	L	M	N	P	Q	wt
0.84	0.96	0.36	0.48	0.19	0.687	0.820	0.07	0.07	0.096	0.42	0.65	--	0.15	0.21	grams
21.27	24.38	9.27	12.19	4.93	17.46	20.83	1.78	1.78	2.44	10.64	16.51	--	3.81	5.43	45

Typical Performance Data

FREQUENCY (MHz)	GAIN (dB)	DIRECTIVITY (dB)	RETURN LOSS (dB)		POUT at 1 dB COMPR. (dBm)	POUT at 3 dB COMPR. (dBm)	NOISE FIGURE (dB)	IP3 (dBm)
			IN	OUT				
10	12.73	87.68	14.08	21.51	10.43	14.80	—	23.17
2000	12.94	49.68	15.62	15.23	13.96	15.70	4.81	24.43
4000	13.07	42.78	19.35	11.80	14.55	16.37	4.44	25.47
6000	12.74	39.99	22.19	10.51	14.40	16.21	4.52	25.58
8000	12.57	37.60	14.91	14.43	14.18	16.01	4.07	25.96
10000	12.27	35.76	14.21	25.15	13.95	15.87	3.60	25.71
12000	12.05	33.99	17.74	16.32	13.96	15.86	3.45	25.13
14000	12.08	31.68	19.41	16.94	13.87	15.80	3.55	24.65
16000	12.01	29.46	15.08	31.20	13.50	15.40	3.83	25.02
18000	11.76	28.75	16.97	28.01	13.13	15.05	3.96	24.28
20000	11.68	27.94	23.54	35.45	12.90	14.86	3.99	24.45
22000	11.79	26.12	23.12	33.42	12.64	14.64	4.12	24.29
24000	11.89	24.45	16.71	32.27	12.44	14.48	4.29	25.62
26000	12.00	23.10	20.42	23.85	12.50	14.42	4.27	24.01
30000	11.89	22.65	11.39	18.11	12.07	14.02	—	25.45
40000	12.10	16.67	18.25	20.80	10.94	12.90	—	22.15

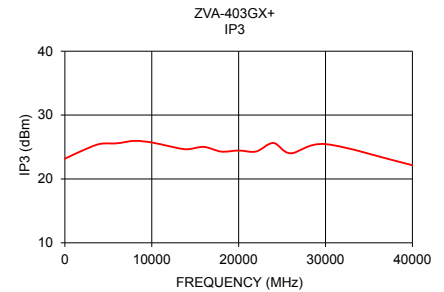
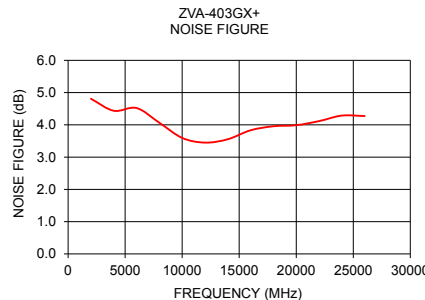
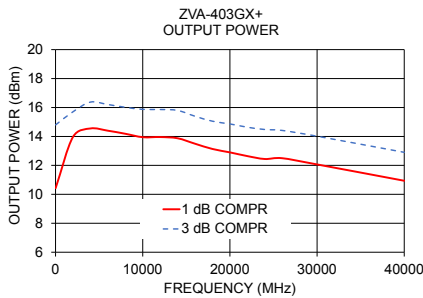
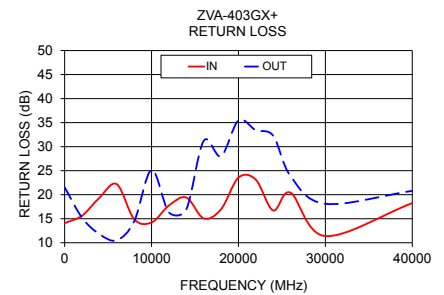
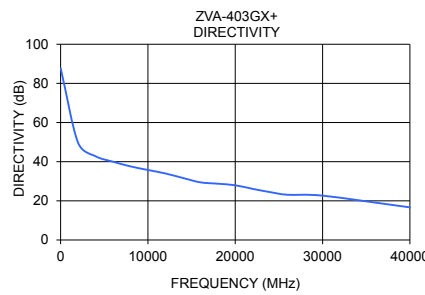
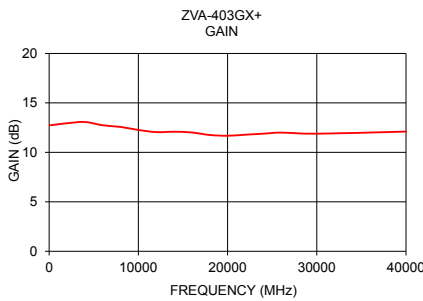

Additional Notes

- A. Performance and quality attributes and conditions not expressly stated in this specification document are intended to be excluded and do not form a part of this specification document.
- B. Electrical specifications and performance data contained in this specification document are based on Mini-Circuit's applicable established test performance criteria and measurement instructions.
- C. The parts covered by this specification document are subject to Mini-Circuits standard limited warranty and terms and conditions (collectively, "Standard Terms"); Purchasers of this part are entitled to the rights and benefits contained therein. For a full statement of the Standard Terms and the exclusive rights and remedies thereunder, please visit Mini-Circuits' website at www.minicircuits.com/MCLStore/terms.jsp

